

Top Rail with Trickle Vent
(Weights & Pulleys)

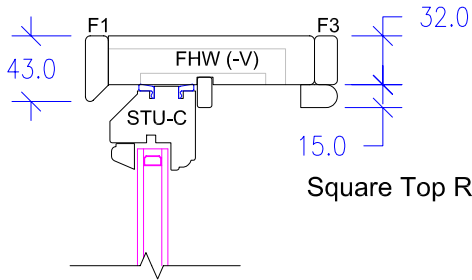

Top Rail without Trickle Vent
(Spiral Balanced)

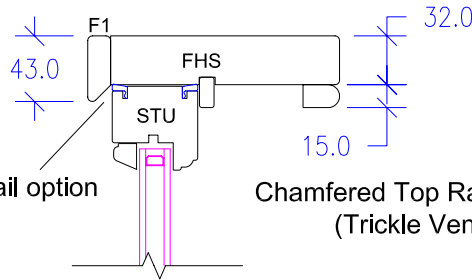

Top Rail with Trickle Vent
(Spiral Balanced)

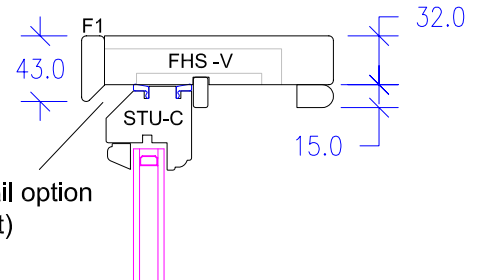

Square Top Rail option

Chamfered Top Rail option
(Trickle Vent)

Option to have Top Rail equal to side boxes on Weights and Pulleys version

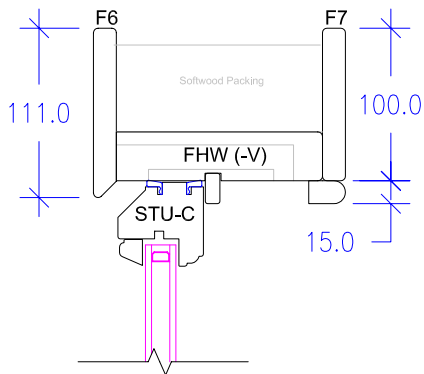

Horizontal Section-Spiral Balances

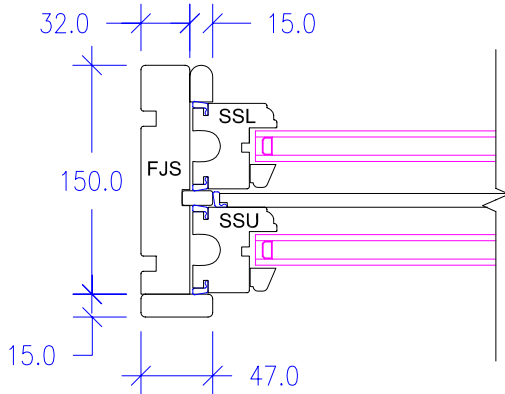

Sash Horn Option

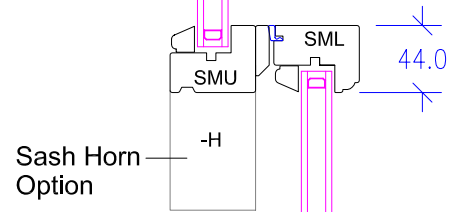

Horizontal Section-Weights & Pulleys

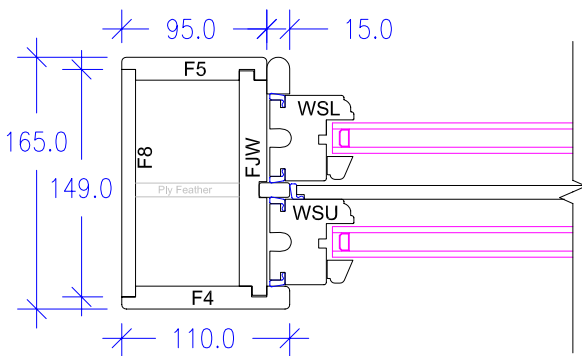

Bottom Rail available with or without Nosing Groove as an option

Standard Nosing

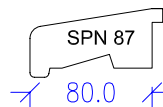

Stub Nosing

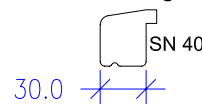

Bottom Rail available with or without Window Board Groove as an option

